

Article number: 03552050

Description: Fluro hydraulic rod end FPR 50N

Measures

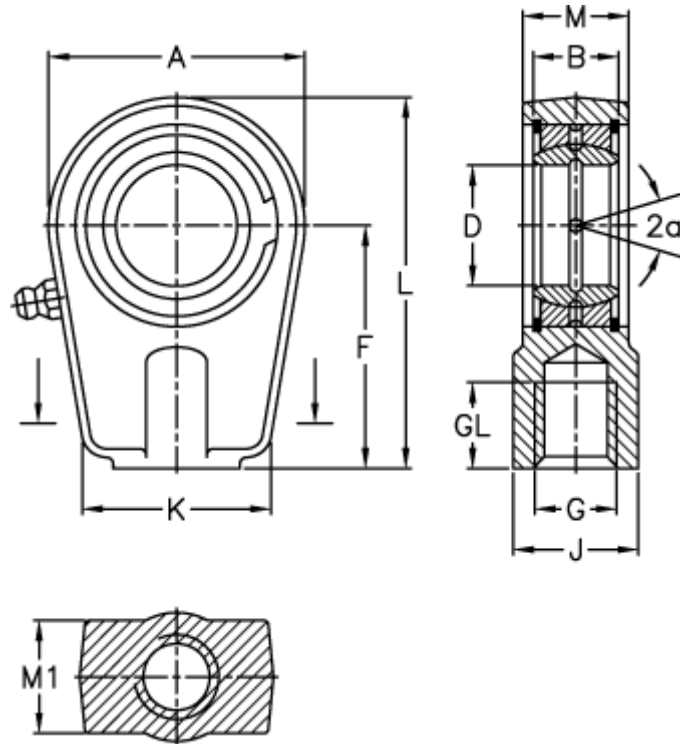

A	= 116	J	= 61
a (degrees)	= 6	K	= 90
B	= 35	L	= 168
D	= 50	M	= 40
Dynamic load C (kN)	= 156	M1	= 37
F	= 105	Static load C0 (kN)	= 365
g	= M45x1,5	Weight	= 3575
GL	= 46		